

Features

- Nominal Zener Voltages: 5.6V, 6.8V, 12V, 15V, 20V
- Ultra-Small Surface Mount Package
- Ideal For Transient Suppression
- **Lead Free/RoHS Compliant (Note 4)**
- **"Green" Device (Note 5 and 6)**



Top View

Mechanical Data

- Case: SOT-363
- Case Material: Molded Plastic. UL Flammability Classification Rating 94V-0
- Moisture Sensitivity: Level 1 per J-STD-020D
- Terminals: Solderable per MIL-STD-202, Method 208
- Lead Free Plating (Matte Tin Finish annealed over Alloy 42 leadframe).
- Orientation: See Diagram
- Marking Information: See Page 3
- Ordering Information: See Page 3
- Weight: 0.006 grams (approximate)

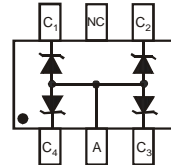

Device Schematic

Maximum Ratings @ $T_A = 25^\circ\text{C}$ unless otherwise specified

Single phase, half wave, 60Hz, resistive or inductive load.
For capacitance load, derate current by 20%.

Characteristic	Symbol	Value	Unit
Forward Voltage (Note 1) @ $I_F = 10\text{mA}$	V_F	0.9	V

Thermal Characteristics

Characteristic	Symbol	Value	Unit
Power Dissipation	P_D	200	mW
Thermal Resistance, Junction to Ambient Air (Note 3)	$R_{\theta JA}$	625	$^\circ\text{C/W}$
Operating and Storage Temperature Range (Note 3)	T_J, T_{STG}	-65 to +150	$^\circ\text{C}$

Electrical Characteristics @ $T_A = 25^\circ\text{C}$ unless otherwise specified

Type Number	Marking Code	Zener Voltage Range (Note 1)			Maximum Zener Impedance (Note 2)				Maximum Reverse Current (Note 1)		Temperature Coefficient of Zener Voltage @ $I_{ZT} = 5\text{mA}$	
		$V_Z @ I_{ZT} = 5.0\text{mA}$			$Z_{ZT} @ I_{ZT}$		$Z_{ZK} @ I_{ZK}$		$I_R @ V_R$		$T_C (mV/^\circ\text{C})$	
		Nom (V)	Min (V)	Max (V)	Ω	mA	Ω	mA	μA	V	Min	Max
QZX363C5V6	K5F	5.6	5.32	5.88	40	5.0	400	1.0	1.0	2.0	-2.0	2.5
QZX363C6V8	K6F	6.8	6.47	7.14	15	5.0	80	1.0	2.0	4.0	1.2	4.5
QZX363C12	KFF	12	11.4	12.7	25	5.0	150	1.0	0.1	8.0	6.0	10.0
QZX363C15	KJF	15	13.8	15.6	30	5.0	200	1.0	0.1	10.5	9.2	13.0
QZX363C20	KMF	20	19.0	21.0	55	5.0	225	1.0	0.1	14	14.4	18.0

- Notes:
1. Short duration pulse test used to minimize self-heating effect.
 2. $f = 1\text{kHz}$.
 3. Device mounted on FR-4 PC board with recommended pad layout, which can be found on our website at <http://www.diodes.com/datasheets/ap02001.pdf>.
 4. No purposefully added lead.
 5. Diodes Inc.'s "Green" policy can be found on our website at http://www.diodes.com/products/lead_free/index.php.
 6. Product manufactured with Date Code UO (week 40, 2007) and newer are built with Green Molding Compound. Product manufactured prior to Date Code UO are built with Non-Green Molding Compound and may contain Halogens or Sb2O3 Fire Retardants.

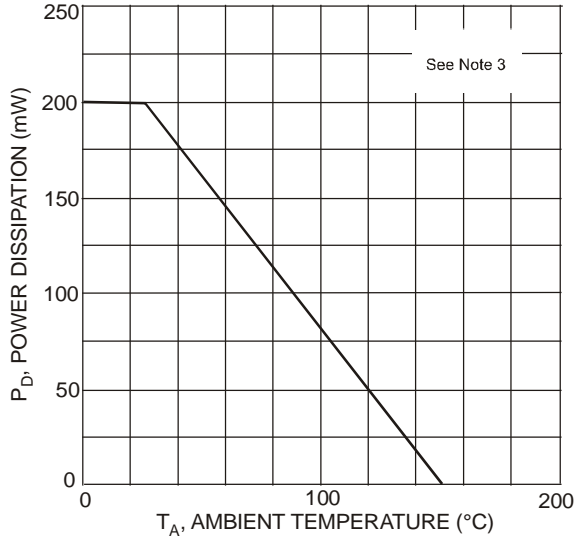

Fig. 1 Power Derating Curve

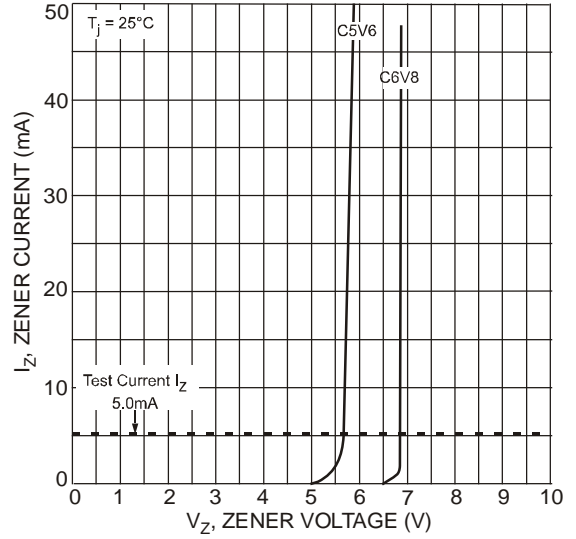

Fig. 2 Typical Zener Breakdown Characteristics

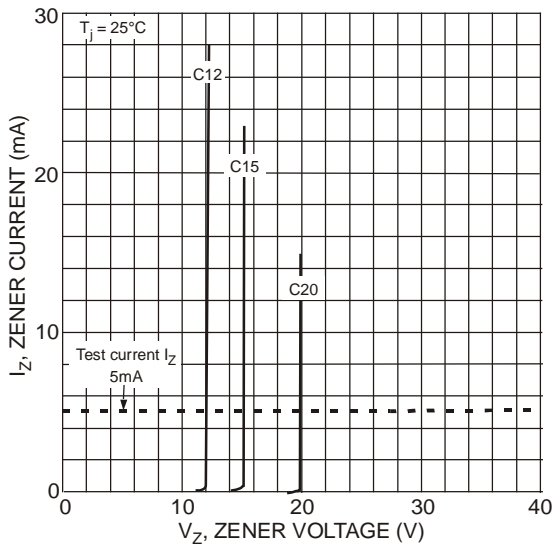

Fig. 3 Typical Zener Breakdown Characteristics

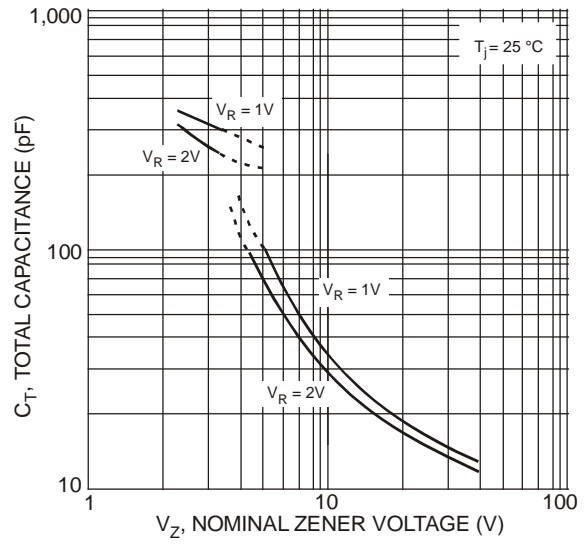

Fig. 4 Typical Total Capacitance vs. Nominal Zener Voltage

Ordering Information (Note 7)

Device	Packaging	Shipping
QZX363C5V6-7-F	SOT-363	3000/Tape & Reel
QZX363C6V8-7-F	SOT-363	3000/Tape & Reel
QZX363C12-7-F	SOT-363	3000/Tape & Reel
QZX363C15-7-F	SOT-363	3000/Tape & Reel
QZX363C20-7-F	SOT-363	3000/Tape & Reel

Notes: 7. For packaging details, go to our website at <http://www.diodes.com/datasheets/ap02007.pdf>.

Marking Information

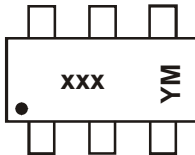

xxx= Product Type Marking Code
 (See Electrical Characteristics Table)
 YM = Date Code Marking
 Y = Year (ex: N = 2002)
 M = Month (ex: 9 = September)

Date Code Key

Year	2000	2001	2002	2003	2004	2005	2006	2007	2008	2009	2010	2111	2012
Code	L	M	N	P	R	S	T	U	V	W	X	Y	Z

Month	Jan	Feb	Mar	Apr	May	Jun	Jul	Aug	Sep	Oct	Nov	Dec
Code	1	2	3	4	5	6	7	8	9	O	N	D

Package Outline Dimensions

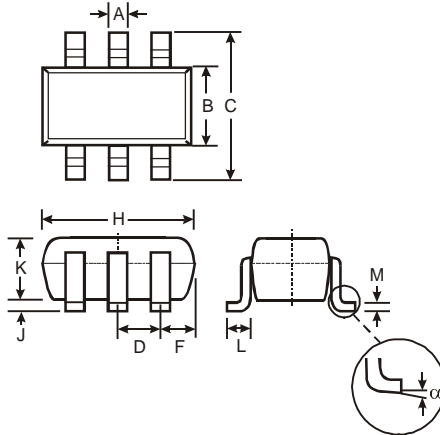

SOT-363		
Dim	Min	Max
A	0.10	0.30
B	1.15	1.35
C	2.00	2.20
D	0.65 Nominal	
F	0.40	0.45
H	1.80	2.20
J	0	0.10
K	0.90	1.00
L	0.25	0.40
M	0.10	0.22
α	0°	8°

All Dimensions in mm

Suggested Pad Layout

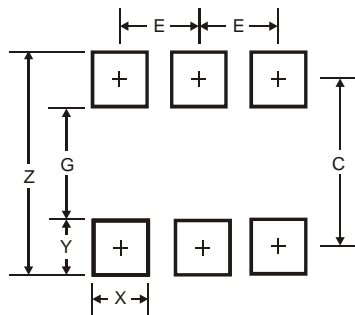

Dimensions	Value (in mm)
Z	2.5
G	1.3
X	0.42
Y	0.6
C	1.9
E	0.65

IMPORTANT NOTICE

Diodes Incorporated and its subsidiaries reserve the right to make modifications, enhancements, improvements, corrections or other changes without further notice to any product herein. Diodes Incorporated does not assume any liability arising out of the application or use of any product described herein; neither does it convey any license under its patent rights, nor the rights of others. The user of products in such applications shall assume all risks of such use and will agree to hold Diodes Incorporated and all the companies whose products are represented on our website, harmless against all damages.

LIFE SUPPORT

Diodes Incorporated products are not authorized for use as critical components in life support devices or systems without the expressed written approval of the President of Diodes Incorporated.